

# SSD counter / bar chair

## Assembly guide

recommandations / recommendations

 deux personnes  
two people

contenu du pack / pack content

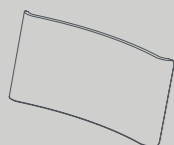

**A** x1  
Dossier / Backrest

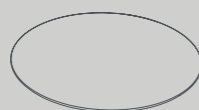

**C** x1  
Assise / Seat

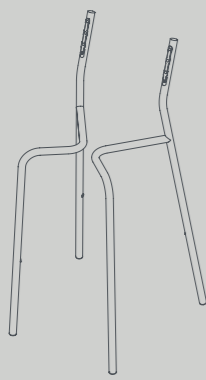

**B** x2  
Pieds / Legs



**D** x1  
Pièce verrou / Lock part

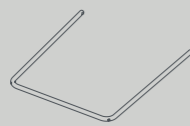

**E** x1  
Arceau / Hoop



**G** x1



**H** x4



**I** x4



**J** x1

\* La chaise SSD mi-haute / haute est livrée avec une clé Allen.  
\* The SSD counter / bar chair is delivered with an Allen key.

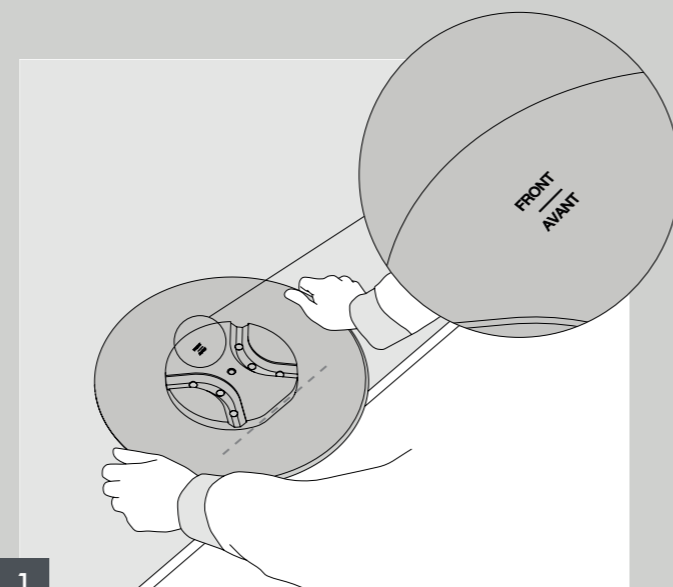

**1**  
Positionnez l'assise (C) retournée sur une table, le côté plat vers vous.  
Place the seat (C) upside down on a table with the flat side facing you.

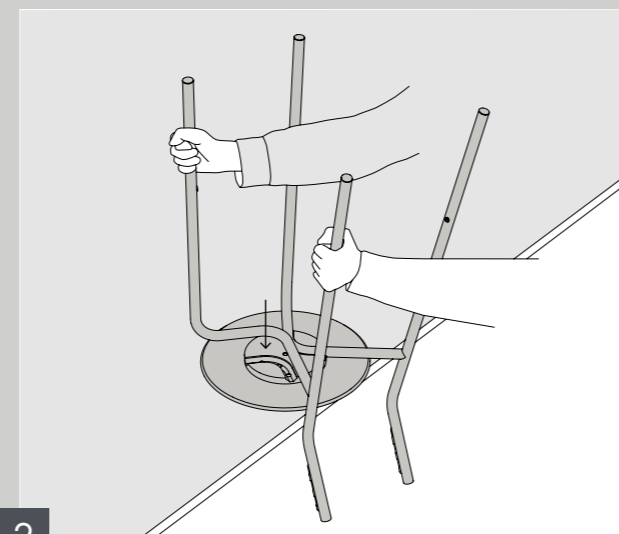

**2**  
Installez les pieds (B) dans les rainures de l'assise (C).  
Position the legs (B) in the slots of the seat (C).

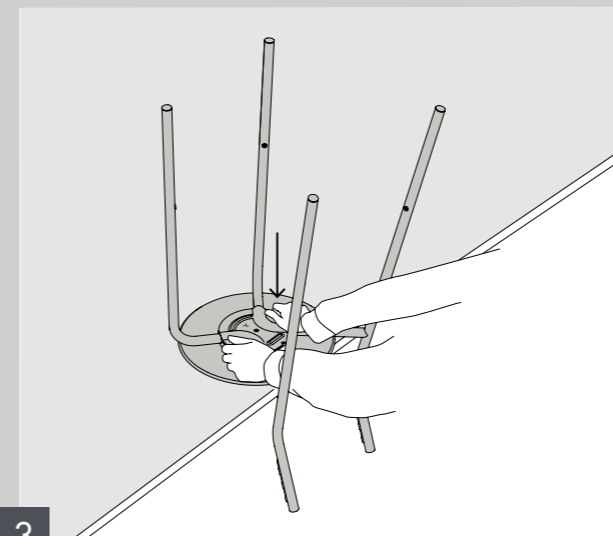

**3**  
Placez la pièce verrou (D) sur les pieds (B).  
Place the lock part (D) on the legs (B).

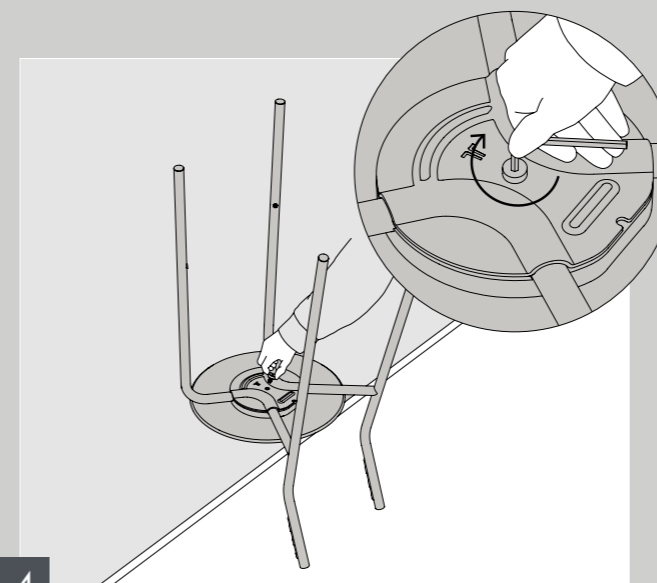

**4**  
Insérez la vis (G) puis serrez-la à l'aide de la clé Allen fournie (J).  
Insert the screws (G) and tighten it with the provided Allen wrench (J).

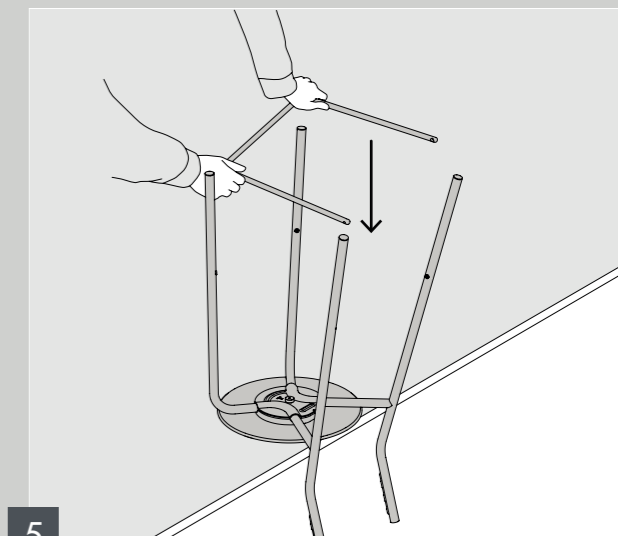

**5**  
Placez l'arceau (E) entre les pieds (B).  
Place the hoop (E) between the legs (B).

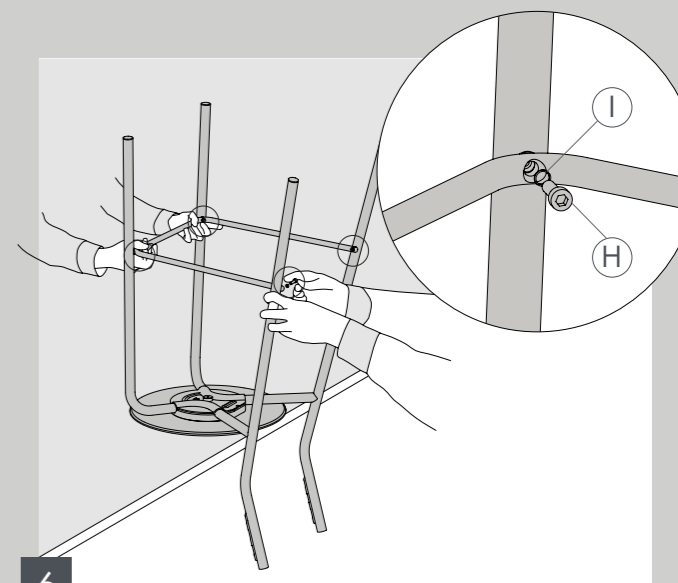

**6**  
Insérez les rondelles (I) et les vis (H) fournies dans les emplacements.  
Insert the provided screws (H) and washers (I) into the slots.

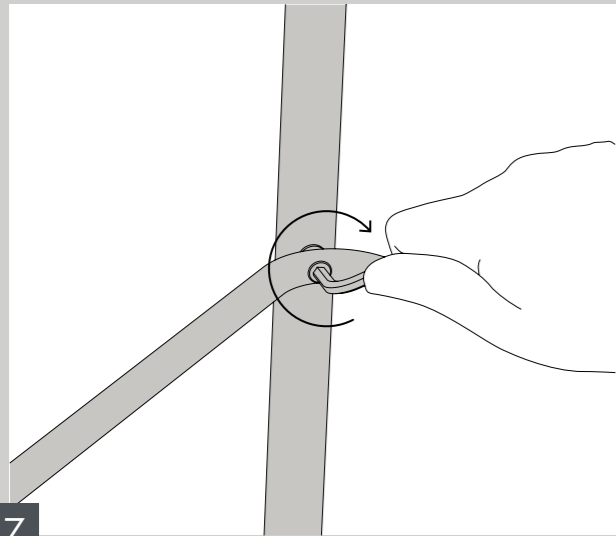

7

Vissez à l'aide de la clé Allen (J).  
Tighten with the Allen wrench (J).

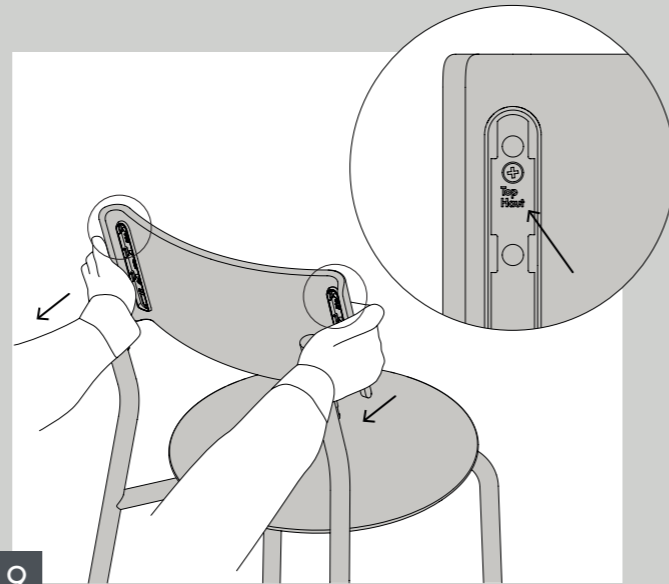

9

Positionnez le dossier (A) sur les tubes.  
Place the backrest (A) on the tubes.



11

Votre chaise SSD mi-haute / haute est prête à être utilisée !  
Your SSD Counter or SSD Bar chair is ready to use!

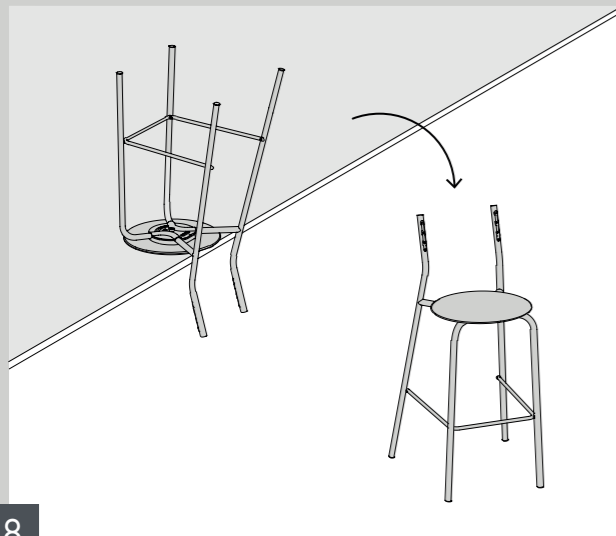

8

Retournez la chaise et posez-la au sol.  
Turn the chair over and place it on the floor.

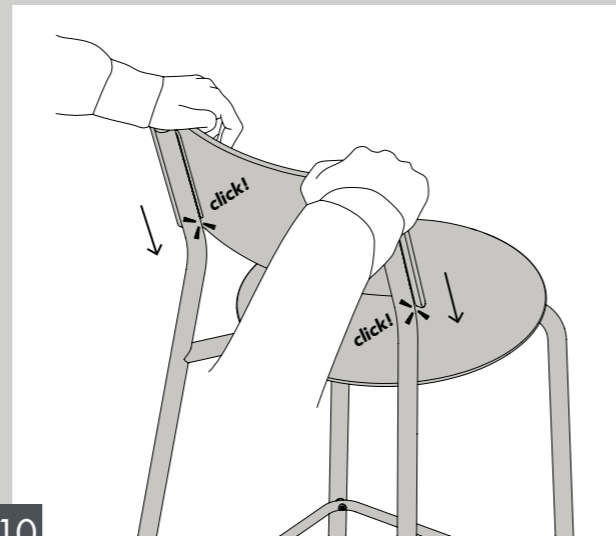

10

Clipsez le dossier (A) en poussant vers le bas.  
Clip the backrest (A) by pushing it downwards.

## SSD counter / bar chair

Assembly guide

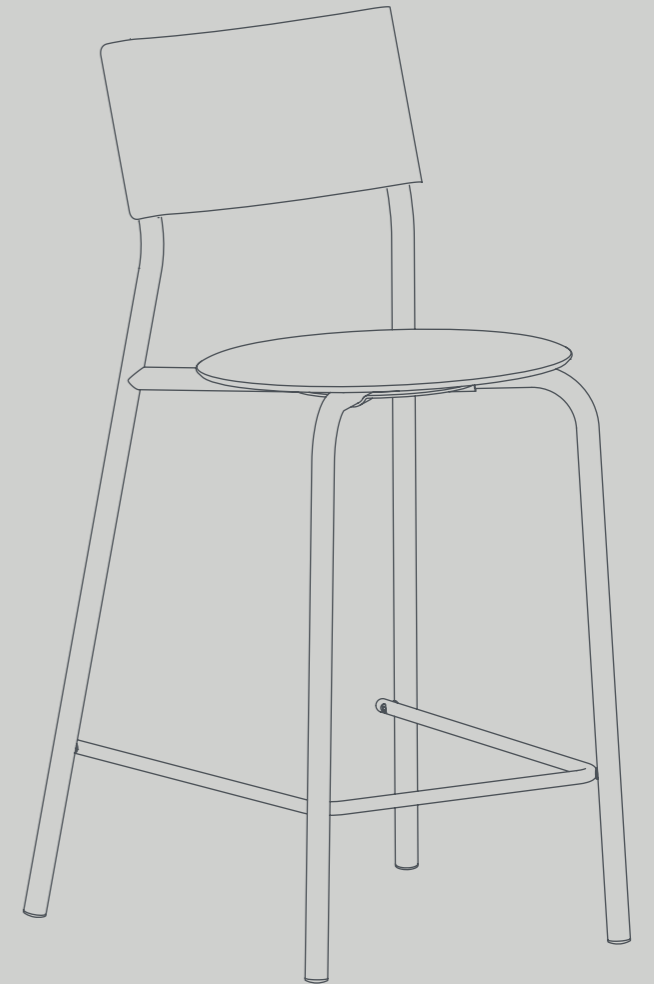

TIPTOE

tiptoe.fr | @tiptoeDesign